7121 Gamma Detector

WINDOW SPECIFICATIONS

Effective diameter (inch/mm)	0.36/9.1
Material	Stainless Steel
Thickness (inch/mm)	0.010/0.254

GENERAL SPECIFICATIONS

Gas filling	Ne +Halogen
Cathode material	446 Stainless Steel
Maximum length (inch/mm)	1.94/49.2
Effective length (inch/mm)	1.5/38.1
Maximum diameter (inch/mm)	0.59/15.1
Connector	Pin
Operating temperature range °C	-40 to +75

ELECTRICAL SPECIFICATIONS

Recommended anode resistor (meg ohm)	10
Maximum starting voltage (volts)	325
Recommended operating voltage (volts)	500
Operating voltage range (volts)	450 - 650
Maximum plateau slope (%/100 volts)	6
Minimum dead time (micro sec)	90
Gamma sensitivity Co60 (cps/mr/hr)	18
Tube capacitance (pf)	3
Weight (grams)	8
Maximum background shielded 50mm Pb + 3mm Al (cpm)	10

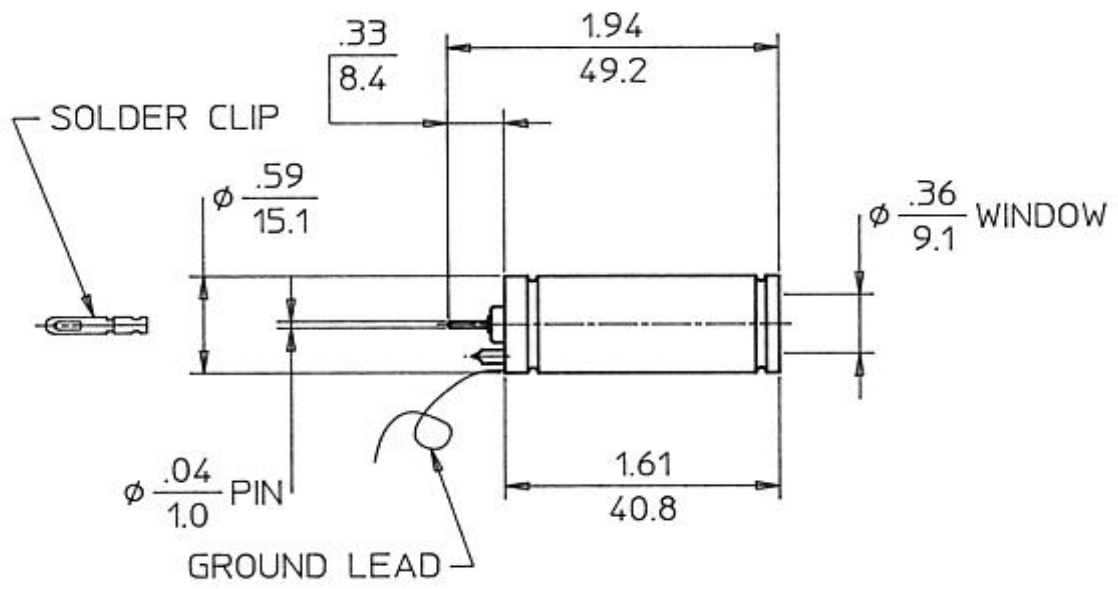

GAMMA SENSITIVITY

TUBE TYPE - 7121

